

HTF ORBITAL FLOOR & DECK SANDER

From Serial Number
01407 (240/240 Volt) & 01181 (110/120 Volt)



OWNERS MANUAL & OPERATING INSTRUCTIONS

CONTENTS

WARNING	1
NORTH AMERICAN SAFETY INSTRUCTIONS	1
MAINS CABLE WIRING - PLUG	1
USE & APPLICATION	1
SPARE PARTS	1
SPECIFICATION	2
SAFETY	2
ASSEMBLY & TRANSPORT	2
INSTALLING ABRASIVE	3
PREPARATION	3
OPERATION	3
HTF SANDING WEIGHT	4
SET UP	4
HOW TO USE	4
WHEN TO USE	4
FLOOR SANDING TECHNIQUE	5
FLOOR TYPES	5
FLOOR SANDING TECHNIQUE	6
FLOOR SANDING ABRASIVE GUIDE	6
SERVICE & ROUTINE MAINTENANCE	7
ELECTRICAL TESTING	8
FAULT FINDING	8
PARTS DIAGRAM	9
PARTS DIAGRAM	10
PARTS LIST	11
CIRCUIT DIAGRAM	12

WARNING

For safe operation of this machine, read and understand all instructions. Look for the 'warning/caution' symbol.

 This symbol means that if you do not follow the instructions injury can occur to the operator and damage to the machine and floor may result.

 **WARNING:** Risk of explosion.

Floor sanding can result in an explosive mixture of fine dust and air. Use this floor-sanding machine only in a well-ventilated area free from any flame, match or source of ignition.

 **WARNING:** Risk of fire.

Never leave the floor sander unattended with dust in the dust bag.

 **WARNING:** Risk of potential injury.

Moving Parts - to reduce the risk of injury, unplug the machine before replacing abrasive sheets or carrying out any form of adjustment or servicing.

NORTH AMERICAN SAFETY INSTRUCTIONS

 **WARNING:** This floor sanding machine must be grounded.

This floor-sanding machine shall be grounded while in use to protect the operator from electric shock. The machine is provided with a three-conductor cord and a moulded three-contact grounding type attachment plug to fit the proper grounding type receptacle. The Green (or Green and Yellow) conductor in the cord is the grounding wire. Never connect this wire to any pin other than the grounding pin of the attachment plug.

This floor-sanding machine is provided with an attachment plug as shown in sketch A. It is intended for use on a nominal 120 volt circuit. If a properly grounded receptacle as shown in sketch A is not available, an adaptor as shown in sketch 'C' should be installed as shown in sketch B if the outlet box that houses the receptacle is grounded. Be sure to fasten the grounding tab with a metal faceplate screw.

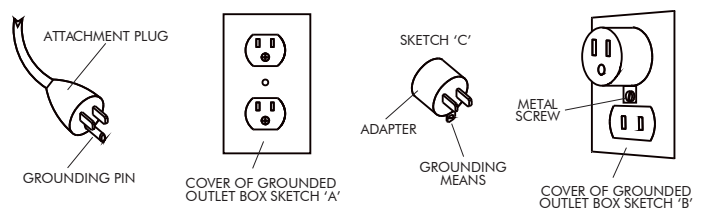

MAINS CABLE WIRING - PLUG

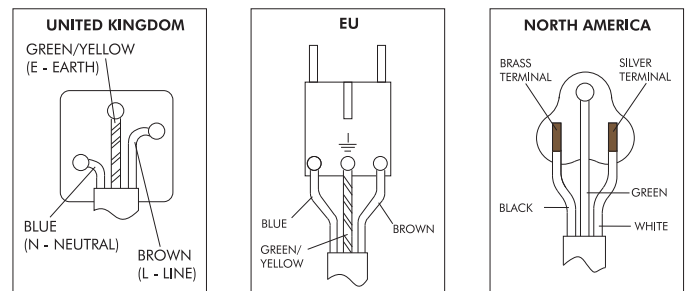

USE & APPLICATION

This machine is intended for commercial use connected with the laying and maintaining of wooden floors and decks.

These types of surfaces may be found both in commercial and household environments.

SPARE PARTS

Use Hiretech genuine spare parts only for service and repair. Use of non-approved parts will void the product warranty. See the back cover of this manual for the terms and conditions of the Hiretech Limited Warranty.

Hiretech reserves the right to make changes or improvements to its products without prior notice.

For the latest product news and updates, spare parts, downloads and service information visit www.hiretech.biz.



SPECIFICATION

The HTF Orbital Floor & Deck Sander will sand wood floors and most types of decking, including fine parquet, engineered and pre-finished wood flooring systems, cork and composition floors to a fine finish. Ideal for sanding between coats of floor varnish and lacquers where a very high quality, score free finish is required. The finally balanced orbital action will not leave swirl marks in the floor surface which may be highlighted when varnished. Designed for sanding floors that are level and in generally good condition where the existing varnish has worn and requires re-finishing. Completely self contained with a powerful dust pickup the HTF-2 is a high performance floor sander suitable for professional and home owner use.

Power Supply	110/120 V 50/60 Hz 220/240 V 50/60 Hz
Off Load Current	110/120 V 8A 220/250 V 5A
Average Load Current	110/120 V 15A 220/250 V 8A
Noise	95dBa at 1 metre (3' 3")
Vibration	8.89 m/s ² r.m.s.
Switch	Bias Off, double pole.
Motor	Continuous heavy duty AC/ DC self cooling 4 brush.
Motor RPM	10,000
Sanding Pad RPM	3,000
Sanding Pad	400mm (15¾") x 115mm (4½") MDF back with hook and loop face.
Drive	Non-slip toothed timing belt and toughened steel pinion and drive gear.
Moving Parts	Sealed for life ball bearings.
Dust Pickup	Seated oversize vacuum fan, disposable paper dust or cloth bag
Abrasive	400mm (15¾") x 115mm (4½") random fibre abrasive pad 280 grit and backing pad. 400mm (15¾") x 115mm (4½") anti-clog adhesive backed sheet 40 to 180 grit
Power Cable	7m (23') Non-marking outer insulation.
Weight Net	45.0kg (94.8lbs) excluding HTF weight.
Shipping Weight	52.0kg (110.3lbs)
Shipping Dimensions	77 x 39 x 57cm (30.3" x 15.4" x 22.4")
Warranty	2 years

 Read the following Safety and Operational notes before using your Hiretech Floor Sander.

SAFETY

1. For safety it is recommended that a residual current circuit breaker (ground fault interrupter) is used with this machine.
2. Check the operating voltage is correct and that the machine is switched OFF (O) before connecting to the power supply.
3. Never attempt to lock the switch in the ON (I) position with tape or by any other means.
4. Always disconnect from the power supply when changing the abrasive, servicing the floor sander, replacing the dust bag or leaving the machine unattended.
5. Always replace the dust bag when the dust in the bag reaches the 'MAX' line or when the machine is left unattended.
6. Never dispose of or empty the contents of the dust bag into a fire or incinerator.
7. Never reuse the paper dust bag or use a non standard bag.
8. Always wear a dust mask when using the floor sander, handling the dust bag or cleaning the machine after use.
9. Wear ear protection when using the floor sander.
10. Ensure adequate ventilation of the work area to avoid the formation of a combustible mixture of flying dust and air.
11. Never smoke when using or servicing the floor sander or when handling the dust bag. Make sure that all possible sources of ignition are removed from the work area.
12. Never expose the machine to rain or damp. Always store in a dry place.
13. Stop the floor sander immediately if damage to the machine or abrasive is suspected.
14. Never allow the power cable to come into contact with the sanding pad when the floor sander is in operation. If the power cable becomes damaged and the inner conductors are exposed switch the power OFF (O) and remove the plug before attempting to move the machine. The cable must be replaced by an authorized agent or qualified electrician using genuine Hiretech® spare parts only.
15. Keep hands, feet and loose clothing away from all moving parts of the machine.
16. Punch down or remove all nails, screws, tacks and other fixings from the floor before sanding to prevent contact with the sanding pad.
17. Keep children and pets clear at all times.
18. If the machine should fail to operate refer to the fault finding guide on page 8.

ASSEMBLY & TRANSPORT

1. The HTF-2 breaks down into two component parts, the main body and handle assembly for easy handling and transport. To assemble loosen the Handle Clamp Handle and fit the handle assembly to the Handle Yoke which should be locked in the upright position. Tighten the Handle Clamp firmly.
2. Pull the Dust Bag Frame down to its operating position. Connect the Handle Cable to the Body Twist Lock at the rear left hand side of the floor sander body. Align the plug with the pins, push in and twist clockwise to lock.
3. Fit a Hiretech disposable paper dust bag following the instructions printed on the bag.
4. Tip the floor sander back so that it rests on the Dust Bag Frame to fit the selected abrasive. Remove the power cable from the handle assembly. Check that the cable is in good condition

and the strain relief and plug are secure. The floor sander is now ready to connect to the power supply and start sanding.

5. To dismantle the floor sander reverse the procedure 1 to 4 above.
6. Always carry the floor sander by the front hand grip and the handle yoke which must be locked in the upright position with the handle detached. The dust bag frame should be stowed in the up position.

HTF Main Components

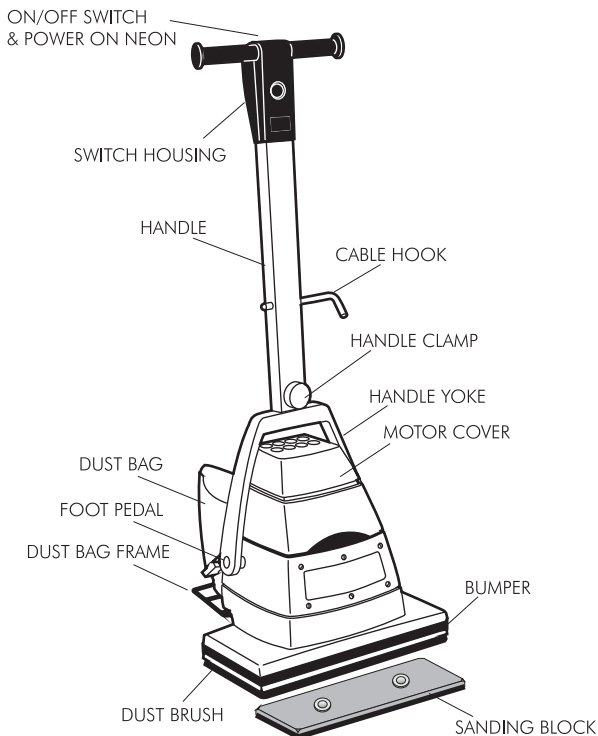

WARNING: Never carry the floor sander by the handle assembly and body or with the handle assembly attached. Failure to observe this rule may result in personal injury and/or damage to the floor sander.

7. Transport the sander with the sanding block and abrasive pad in place this will help maintain the dust brushes in good condition. Always ensure that the floor sander is secure and cannot move when being transported in a vehicle. The floor sander is heavy. Take care when lifting and carrying the machine.

INSTALLING ABRASIVE

1. Ensure the power cable is disconnected from the power supply.
2. Lock the handle in the upright position and tip the floor sander backwards so that it rests on the dust bag frame. If a sanding block is already fitted the abrasive may be fitted with the sanding block left in place or it may be removed if required.

To remove the sanding block take hold of each end of the block and pull it off its mounting posts. Take care to pull the block off evenly and avoid trapping your fingers between the block and the body of the floor sander.

3. Refer to the Abrasive Guide on page 6 for the correct abrasive to use.
4. Abrasive Pad - fit an abrasive pad to the sanding block. Carefully line the pad up with the face of the sanding block and push down. The pad is both a fine abrasive and a backing pad for the coated abrasive sheets. It is important

that the pad is maintained in good condition and not used beyond its useful working life.

CAUTION: Do not use any other type of abrasive pad or backing material as this may damage the floor and/or floor sander.

5. Abrasive Sheets - peel off the backing to exposure the adhesive pad and carefully fix the abrasive to the face of the abrasive pad making sure it is in line. When changing abrasive sheets peel off carefully so as not to destroy the face of the abrasive pad.
6. With the abrasive fixed to the sanding block re-fit the block (if removed) to the floor sander.
7. Stand the floor sander up, it is now ready to use.
8. Periodically check that the abrasive pad is still in line with the sanding block. If the machine is tipped back when in operation the abrasive pad may become misaligned.

PREPARATION

1. Where possible remove all furniture from the room. The HTF-2 Floor Sander features an efficient dust pick-up, however, some dust will escape. Protect all vulnerable furnishings with dust sheets, masking films and tape.
2. Remove all tacks, staples and other unwanted fixings from the floor. Failure to do so will result in damage to the sanding pad and abrasive sheet or pad.
3. Punch all nails below the surface of the floor using a suitable nail punch and hammer. Any screws used to fix boards should be counter sunk below the surface. During sanding, any nails or screws that become exposed must be punched or counter sunk further.
4. Firmly fix all loose boards or blocks.
5. Remove heavy wax, grease and dirt deposits by hand.
6. Sweep and vacuum the floor thoroughly to remove dirt and discarded fixings.
7. Ensure good ventilation by opening windows.

OPERATION

1. Move the floor sander to the location of your work.
2. Make sure the switch is in the OFF (O) position then connect the main cable to a suitable power supply ideally located behind or to one side of the machine and work area.
3. Wear a dust mask and ear defenders.
4. Hold the handle with both hands and depress foot pedal with your right foot. This will release the handle.
5. Switch ON by pushing the ON/OFF switch down using the thumbs of one hand to ON (I) position and hold in place. Start moving immediately. To switch OFF (O), release the pressure on the switch and it will automatically return to the OFF position.

CAUTION: the HTF-2 Floor Sander is a powerful machine always ensure you have a firm grip before switching on.

6. Follow the instructions carefully for sanding and re-finishing a floor. Walk slowly forward and back, working progressively across the floor. Do not dwell in one place. The floor sander will glide easily across the surface of the floor.
7. When the dust in the dust bag reaches the 'MAX' line stop sanding. Switch OFF, disconnect the power cable from the power supply and remove the paper dust bag. Turn the top of the paper dust bag over to stop the escape of dust and

dispose of into a suitable container. Fit a new paper dust bag. Reconnect to the power supply and continue sanding. Never reuse the paper dust bag or attempt to empty it.

6. Change the abrasive when the quality of the sanding is reduced or the abrasive becomes clogged.
7. When taking a break from work switch OFF (O) and disconnect the power cable from the power supply, remove and dispose of the paper dust bag.
9. On completion disconnect the power cable from the power supply. Remove and dispose of the paper dust bag. Lock the handle in the upright position and stow the power cable. Lock the dust bag frame in its up position. Leave the old abrasive pad in-place to protect the dust brushes. Carry out maintenance as recommended in Maintenance and Servicing.

⚠ DANGER: *never leave the floor sander unattended with dust in the dust bag. Always remove the dust bag and dispose of into a suitable container.*

⚠ CAUTION: *to prevent damage to the floor surface, work piece or machine follow these rules.*

- i. Always ensure that the floor sander is moving when in operation and the sanding pad is in contact with the floor.
- ii. Never lift the back or front of the machine when sanding.
- iii. Never apply pressure to try and increase the rate of sanding. Damage to the floor will occur.
- iv. Never bounce or drop the floor sander on to the floor, always lower the machine gently.
- v. Never dwell in one place, move steadily at all times.
- vi. Never allow the power cable to come into contact with the sanding pad.

HTF SANDING WEIGHT

The HTF is a high performance orbital floor sander designed for the sanding and refinishing of all types of wood flooring and decking.

Wood floors and decks come in a wide range of soft and hard woods with many different types of stains and finishes. Productive sanding means getting the abrasive to cut at its optimal speed and pressure for the type of wood and surface finish that is being sanded.

The HTF Sanding Weight allows the operator to add weight to the HTF via a simple 'clip on clip off' system to optimize sanding performance when needed.

SET UP

The HTF Sanding Weight is supplied 'empty' and must be filled to add weight. Use builders sand as detailed below.

1. Remove the cap.
2. Fill the HTF Sanding Weight with dry builders sand, also known as sharp sand or concreting sand, using a hand trowel. As you fill the weight with the first few trowel full's shake the weight to help settle the sand into the corners.

Do not use coarse sand or aggregates with stones. Use dry sand only. Do not fill with water or any other fluid.

3. When the weight is approximately half full fit the weight to the HTF (see below 'How to Use'). Place the HTF on a wooden board that you can sand. Fit an abrasive backing pad and a HTF sanding sheet of any grit. If you have a used abrasive

backing pad and sanding sheet use these.

4. Run the HTF for two (2) minutes to vibrate the sand down into the weight, Remove the weight and continue to fill with sand.
5. Repeat operation 3 and 4 above until the weight is full and the sand is approximately 2.5cm (1") from the top of the cap. Refit the cap.

Do not over fill. Take care that any spilt sand is brushed off the weight before fitting to the HTF. Do not allow sand to enter the HTF motor or any other working parts.

When full the weight will be approximately 27kg (63lbs). As the HTF is used the sand will settle and become more compact within the body of the weight. Additional sand can be added if required. Do not exceed the recommended maximum weight of 30kg (66lbs).

Note the actual weight will vary depending on the grade and type of sand used.

MAXIMUM WEIGHT : 30kg (66lbs)

HOW TO USE

1. The HTF Sanding Weight is simply clipped onto the HTF. Use both hands to lift the weight, holding the weight as illustrated below.
2. Stand in front of the HTF and rest the front edge of the weight onto the HTF base. Then tip the weight back so that the back lugs fit over the back edge of the HTF base. Take care not to trap your fingers between the weight and the HTF handle.
3. To remove the weight reverse the procedure as detailed in 2 above.

WHEN TO USE

Use on hard wood floors and engineered floors with hard surface finishes. Use with 40 grit and 60 grit abrasives for rapid stock removal.

Note that too much weight will increase friction and reduce the life of the abrasive. The abrasive will only 'cut' as deep as the abrasive grit size. Always test sand first before using the HTF Sanding Weight.



FLOOR SANDING TECHNIQUE

HT8 Drum Floor Sander - a powerful floor sander designed for the rapid levelling and sanding of all types of wood flooring excluding thin laminated or veneered floors. Load the sander with abrasive making sure that it is skin tight around the drum. Loose sheets will tear. Place the sander on the right hand wall (unless you are making an angled cut on uneven floors) with about two thirds of the floor in front of you. Start the sander with the drum off the floor then walk forward at an even pace and ease the drum on to the floor. As you near the end of the pass, gradually raise the drum off the floor. Practice this technique before turning on the sander.

Cover the same path you made on the forward cut by pulling the machine backwards and easing the drum to the floor as you begin the backward pass until you reach the original starting point, then ease the drum off the floor.

When two thirds of the floor is sanded, turn the floor sander around and sand the remaining third in the same way. Overlap the one third area by 0.6 to 0.9 meters (2 to 3 feet) with the two thirds area to blend the two areas together.



WARNING: *never bounce the sanding drum or dwell in one place as this will sand dips and hollows in the floor.*

HT7 Disc Floor Sander (Edger) - a powerful disc floor sander designed for sanding along the edges of a floor without damaging the baseboards or mouldings. Also suitable for smaller areas where the HT8-1.2 Floor Sander will not reach like stair treads and closets load the abrasive disc making sure the retaining bolt is tight. Start the edger with the disc off the floor then lower the disc to the floor as you move the sander. Work progressively moving the sander in a sweeping motion from side to side.

HTF Orbital Floor Sander - a orbital action floor sander designed for re-finishing, sanding between coats of varnish and re-surfacing floors in good condition. Load the abrasive sheet, pad or strip. Start the sander, move immediately and sand in the direction of the grain using the same technique as the drum floor sander. For difficult to reach areas use the disc floor sander with a fine grit abrasive, or sand by hand.

Hand Sanding - to sand difficult to reach areas scrape and sand the floor by hand. Use a scraper to remove old finishes, always scraping in the direction of the grain, and then sand by hand using the same grit abrasive as you finished with when machine sanding. See Floor Sanding Technique diagrams on page 6.

FLOOR TYPES

Plank & Strip Floors

Old floors in good condition - when the floor is in good condition - no uneven edges, cupping or crowning of planks and strips - and you want to re-surface the floor, sanding back to new wood, start sanding in the direction of the planks or strips - with the wood grain. Start with a medium grit abrasive. Complete the first cut with the HT8-1.2 Floor Sander then sand up to the baseboards and door thresholds with the HT7-2 Disc Floor Sander, using a medium grit abrasive, blending the edges in with the main floor area. Sweep the floor. Using a medium/fine grit abrasive, sand the main floor area with the drum sander and then complete the floor with the edger using a fine grit abrasive. Sweep the floor. Finish sanding the main floor area with the drum floor sander using a fine grit abrasive. If the floor is in particularly good condition (level with no deep scratches or blemishes) you may re-surface the floor using the

HTF-2 Floor Sander, however, as the sanding action of this machine is less aggressive than the HT81.2 Floor Sander the job will take more time.

Uneven floors - when the floor is uneven sand diagonally at 45o across the room in both directions using the HT8-1.2 Floor Sander with a coarse grit abrasive. Only make one cut on both diagonals, this will achieve a basic level. Now complete the floor as for a level strip or plank floor. Use the same grit abrasive as was used on the 45o cut for the first cut parallel to the planks or strips.

Floors with an existing finish - when re-finishing a floor remove as little of the existing surface as possible. If the old finish is worn and the floor is generally in good condition use the HTF-2 Floor Sander with Hiretech abrasive pads and strips which have been especially designed for re-finishing floors. These will maintain the integrity of any stain used to colour the wood and prepare the surface for a new coat of finish. If the floor is badly marked and scratched and has to be sanded back to new wood use the HT8-1.2 Floor Sander and HT7-2 Disc Floor Sander. Always try a medium grit paper first, particularly on a diagonal cut. If 90% of the old finish is removed and the floor is generally levelled, you do not need to use a coarse grit abrasive.

Engineered and Thin Floors

Use the HTF-2 Floor Sander for engineered or thinner floors that may have been subjected to repeated sanding. The HTF-2 will remove old surface finishes and prepare the floor for re-finishing. Sand the floor using the same method as a strip, plank, or parquet floor. If the floor has deeper scratches or marks these should be sanded out by hand and blended in with the main floor. To check the wood depth in the floor remove a baseboard or moulding from around the edge of the floor. This should provide access to the edge of the floor for inspection.

Parquet & Block Floors

The grain of the wood will run in a number of directions so sand the floor in the direction of the main source of natural light in the room. If there is no source of natural light sand in the direction of the longest side of the room or, if the room is square, in the direction the furniture is laid out and how people normally use and view the room.

This technique will help mask any imperfections in the floor. Complete the sanding operation as detailed for plank or strip floors.

Between Coats of Finish (varnish)

Use the HTF-2 Floor Sander to sand between coats of floor finish, particularly when using water based varnishes. These types of finishes tend to raise the wood grain when first applied to raw wood. Allow each coat of varnish to dry completely following the manufactures directions. Use Hiretech abrasive pads to sand between each coat of varnish. The fine abrasive pads will remove light brush/applicator marks and raised grain while maintaining the integrity of the coat of varnish applied.

FLOOR SANDING ABRASIVE GUIDE

Abrasive Grade	Floor Type and Condition
Grit P24 Open Coat (Very Coarse non-glogging)	For removing surface coatings from old floors such as varnish, stains and wax polishes. For the rapid sanding and removal of scratches and marks. Sanding level the joints of sub-flooring like particle board and masonite.
Grit P24 (Very Coarse)	For the rapid sanding and removal of scratches and marks. Sanding level the joints of sub-flooring like particle board and masonite.
Grit P36 to P50 (Coarse/Medium)	For removing surface coatings from old floors such as varnish, stains and wax polishes. For the rapid sanding and removal of scratches and light marks. Sanding level the joints of sub-flooring like particle board and masonite.
Grit P60 to P80 (Medium)	For the rapid sanding and removal of scratches and light marks. Sanding level the joints of sub-flooring like particle board and masonite.
Grit P100 to P120 (Medium/Fine)	Intermediate sanding of all types of wood floor. For final sanding of all types of wood floor.
Grit P150 - P180 (Fine/Very Fine)	For final sanding of all types of wood floor. First sanding of cork or composition floors. For sanding between coats of solvent based and 2 pack varnishes.

DO NOT OVER-SAND USE ONLY AS HEAVY GRADE ABRASIVE AS IT TAKES TO DO THE JOB. PROGRESS FROM FIRST GRADE USED THROUGH FOLLOWING GRADES TO REMOVE ALL VISIBLE SANDING MARKS. DO NOT MISS A GRADE.

Hiretech Abrasives	HT8/DUR FLOOR SANDER SHEET 20 & 50/CASE	HT8 EX FLOOR SANDER BELTS 5/CASE	HT7/SUPER 7 EDGER DISC FIBRE BACKED 25/CASE	HT7/SUPER 7 EDGER DISC PAPER BACKED 25 & 50/CASE	HTF FLOOR SANDER SHEET ADHESIVE BACKED	HTF ABRASIVE PAD 20/CASE
P16	-	-	01025	-	-	-
P24 Grit Open Coat	01001	-	-	01044	-	-
P24 Grit	01002	01010	01026	-	-	-
P36 Grit	-	01011	-	-	-	-
P40 Grit	01003	01012	-	01045	01750	-
P50 Grit	-	01013	01027	-	-	-
P60 Grit	-	01014	-	-	01751	-
P80 Grit	01004	01015	01028	01046	01752	-
P100 Grit	-	01016	-	-	-	-
P120 Grit	01005	01017	01030	01048	01754	-
P150 Grit	-	01018	-	-	-	-
P180 Grit	-	-	-	-	01756	-
P280 Grit/Backing Pad	-	-	-	-	-	01769

FLOOR SANDING TECHNIQUE

Level uneven floors.

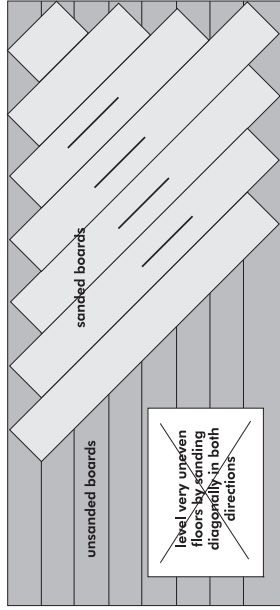

Sand main floor area.

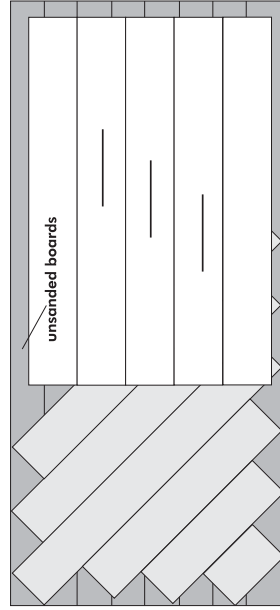

Plank and Strip Floors - sand in the direction the boards are laid, with the wood grain.

Parquet and Wood Block Floors - sand in the direction of the main source of natural light. If there is no natural source of light, sand in the direction of the longest side of the room. If the room is square, sand in the direction the furniture is laid out and how people normally use the room.

Sand and blend edges in with main floor area.

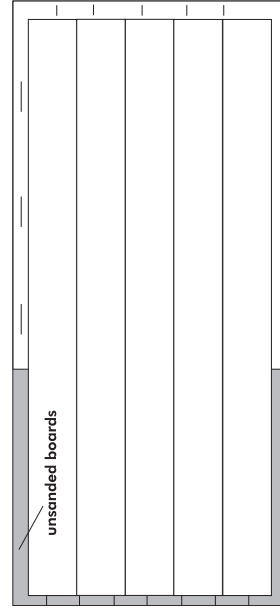

SERVICE & ROUTINE MAINTENANCE



CAUTION: maintenance and repairs must be carried out by authorized personnel only. To prevent injury, always remove the power cable from the power supply before undertaking any work on the machine. Do not operate this machine unless it is fully assembled and all guards are in place. Use Hiretech genuine spare parts only.

General

1. Always make a list when first examining the machine, to remind you of parts or action needed on completion of routine maintenance.
2. The HTF-2 Floor Sander is subject to high speeds and vibration, all screws should be fitted using a suitable thread lock compound.
3. The HTF-2 Floor Sander needs no lubrication during routine servicing.
4. Always ensure that the electrical supply is disconnected before starting any routine servicing or repair.
5. Follow a regular schedule of routine maintenance to keep your HTF-2 Floor Sander in good working.

Visual Inspection

1. To clean the machine and remove dust, use a vacuum cleaner to avoid damage and prevent inhalation of dust.
2. Examine all external parts of the floor sander making sure there is no damage. Check the condition of the Dust Brush and Bumper around the base of the floor sander, both of which should be undamaged and in good condition. Check that the Handle Yoke unlocks and moves freely in its operating position.
3. Examine the sanding pads. These should be undamaged and in good condition. They should fit firmly to the fixing posts and pivot slightly forward and back.
4. Examine the power cable for damage. If the outer insulation shows the slightest of abrasions or the inner conductors are exposed then the cable must be replaced. The cable must not be repaired with tape or insulation sleeve.
5. Ensure all labels are sound, readable and secure.
6. Check that the rear wheels are sound and moving freely. If a wheel is found to be loose or damaged then the floor sander will not sand or handle properly. Check and reset the wheels (see Setting the Wheels on page 8). Replace damaged wheels.
7. Check the condition of the Dust Bag Frame making sure that it hinges down in to its operating position and locks securely when stowed.

Dust Control

1. Remove the handle and lay the floor sander on its face. Remove the sanding pad if fitted and inspect the underside for the build up of dust or pieces of abrasive. Clean as required.
2. Inspect the condition of the Dust Brush. The brush should be replaced if damaged or badly worn.

Drive

1. The drive gears and drive belt do not require maintenance under normal operating conditions.

Lubrication

1. The HTF-2 Floor Sander features sealed for life bearings which do not require any lubrication. In the unlikely event that a bearing has to be replaced use a Hiretech genuine spare part only as the grease contained in the bearings is special. A standard bearing is not suitable and may result in further damage.

Care of Motor

1. The motor must be kept clean and free from grease and dust.
2. The motor brushes must be checked regularly. Replace ALL FOUR motor brushes when any one brush has worn to 12mm (1/2") or less in length. Brushes MUST slide freely in the brush holders.
There is no need to remove or disconnect any internal leads when changing the brushes, only the small braided shunt (pigtail) connected to the motor brush is disconnected to release the brush.
3. To replace the motor Brushes ;
 - i. Remove the four screws from the Motor Cover and lift the cover off.
 - ii. Remove the four Spring Brushes and set to one side. The springs are removed by pushing the spring tag in towards the brush and lifting out.
 - iii. Using a cross recess screwdriver remove the four brush shunt (pigtail) retaining screws and lock washers.
 - iv. Remove the four brushes.
 - v. Thoroughly clean the brush assembly and housing using a soft brush and a suitable vacuum cleaner.
 - vi. Inspect the four brushes for damage or wear and if any one brush is found to be damaged or worn to a length of 12mm (1/2") or less in length then replace all four brushes. Always replace all four brushes together.

Motor Brush

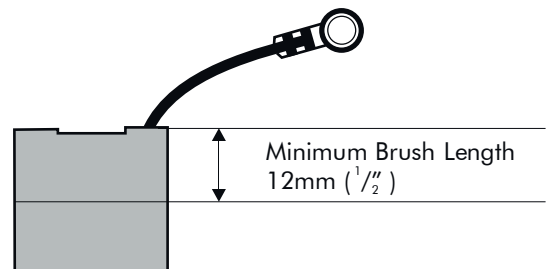

- vii. When replacing brushes ensure that each brush moves freely in each brush holder and fit the brush with the shunt (pigtail) in such a position as to allow free movement throughout the brushes life. Ensure that each brush shunt is connected securely with the screw and lock washer (two spare screws and washers are provided with each pack of brushes). The brush should be fitted so that the brush shunt (pigtail) is at the bottom of the brush.
- viii. Refit the brush springs by inserting into the holder with the coil spring over the brush then push in until the tag comes into contact with the holder, slide the tag away from the brush and release. The brush spring will clip into position. Check the springs and brushes for correct alignment and free movement.
- ix. Finally check that all leads and cables are clear of moving parts and will not be trapped when refitting the cover motor.

x. Refit the cover motor and secure with the four screws.

Setting the Wheels

 **CAUTION:** under normal operating conditions the wheels should not have to be adjusted. However, should you suspect the wheels have gone out of adjustment follow the procedure below to check and reset the wheels.

1. Remove the handle and turn the floor sander upside down so that it rests on the motor cover. Take care, the floor sander is heavy and can easily over balance. Make sure that it is well supported.
2. Fit the sanding block to the floor sander, making sure that it is firmly seated.
3. Place a block of wood or other solid material on the face of the sanding block 16mm (5/8") high by 114mm (4½") wide across the full width of the sanding block.
4. Place a straight edge, a steel rule is best, across the centre of one wheel and the block of wood. If the wheels are adjusted correctly there will be no gap across the whole width of the block. If you see a gap the wheels need adjustment.

If the gap is at the rear of the block toward the back of the floor sander, the wheels are too low. If the gap is at the front of the block, toward the front of the floor sander the wheels are too high.

5. If the wheels need adjustment. Loosen the Axle Clamp screws located under the axle which will be facing you when the floor sander is upside down resting on the motor cover.
6. Rotate the axle via the socket head screw located in the centre of the wheels. As you rotate the axle via the socket head screw the wheels will rise or fall. Adjust the wheels so that the straight edge rests on the centre of the wheels and the wood block so that there is no gap across the whole width of the block.

7. When the wheels are correctly adjusted tighten the axle clamp screws. Check the socket head screws in the centre of the wheels are tight.

ELECTRICAL TESTING

 **CAUTION:** testing for electrical safety should only be undertaken by a competent person and all results recorded. Do not exceed 1250 volt insulation test duration of 3 seconds

1. Examine the power cable for damage. If the outer insulation shows the slightest of abrasions or the inner conductors are exposed then the cable must be replaced. The cable must not be repaired with tape or insulation sleeve.
2. Open and check the mains plug for condition, loose connections, damaged wires etc. Ensure that the strain relief of the plug is correctly secured to the outer cable insulation. This does not apply if the plug is moulded on to the power cable.
3. Remove the question switch housing screws and lift separate the switch housing. Check the switch, connections, leads etc. Pay special attention to any gaskets, 'O' rings and seals intended to exclude dust from the switch and switch housing area. These must be maintained in good condition.
Carefully brush and vacuum clean the switch housing.
4. Refit the switch housing taking care not to trap any leads.
5. Using a piece of insulation tape or a small soft wedge lock the bias off switch in the 'ON' position.
6. Use the standard procedure test for electrical safety. Do not exceed 1250 volt insulation test duration of 3 seconds.
5. Record the test results.
6. Complete a functional (run) test and record results.

 **CAUTION:** when undertaking a functional run test make sure the machine is secure. Remember the sanding pad will rotate.

FAULT FINDING

FAULT	CAUSE	ACTION
The machine does not run.	The power cable is not connected to the power supply. The motor brushes are worn. The voltage is too low.	Connect the power cable to the power supply. Replace the motor brushes. Check the main power complies with the machine's serial plate data.
The machine will not pickup dust.	The dust bag is full. There is an obstruction in the dust pick-up.	Replace the paper dust bag or empty the cloth dust bag. Disconnect the machine from the power supply, tip the machine back and remove the sanding pad, check for obstruction.
The machine does not sand evenly. The sanding pad is damaged and replace the sanding pad evenly. Check	The sanding pad is damaged. The wheels are out of adjustment.	Check and replace the sanding pad. Check and adjust the wheels.
The sander does not glide easily in a straight line.	The machine is not being operated properly. The wheels are out of adjustment. The Abrasive Pad is worn	Read the instructions, do not apply pressure when sanding. Check and adjust the wheels. Replace the Abrasive Pad
The machine runs slow.	The voltage is low. A motor brush is not making contact.	Check the supply voltage. If an extension lead is being used, is it undersize and/or is it coiled. Check and refit or replace the motor brushes.

PARTS DIAGRAM

HTF Orbital Floor & Deck Sander

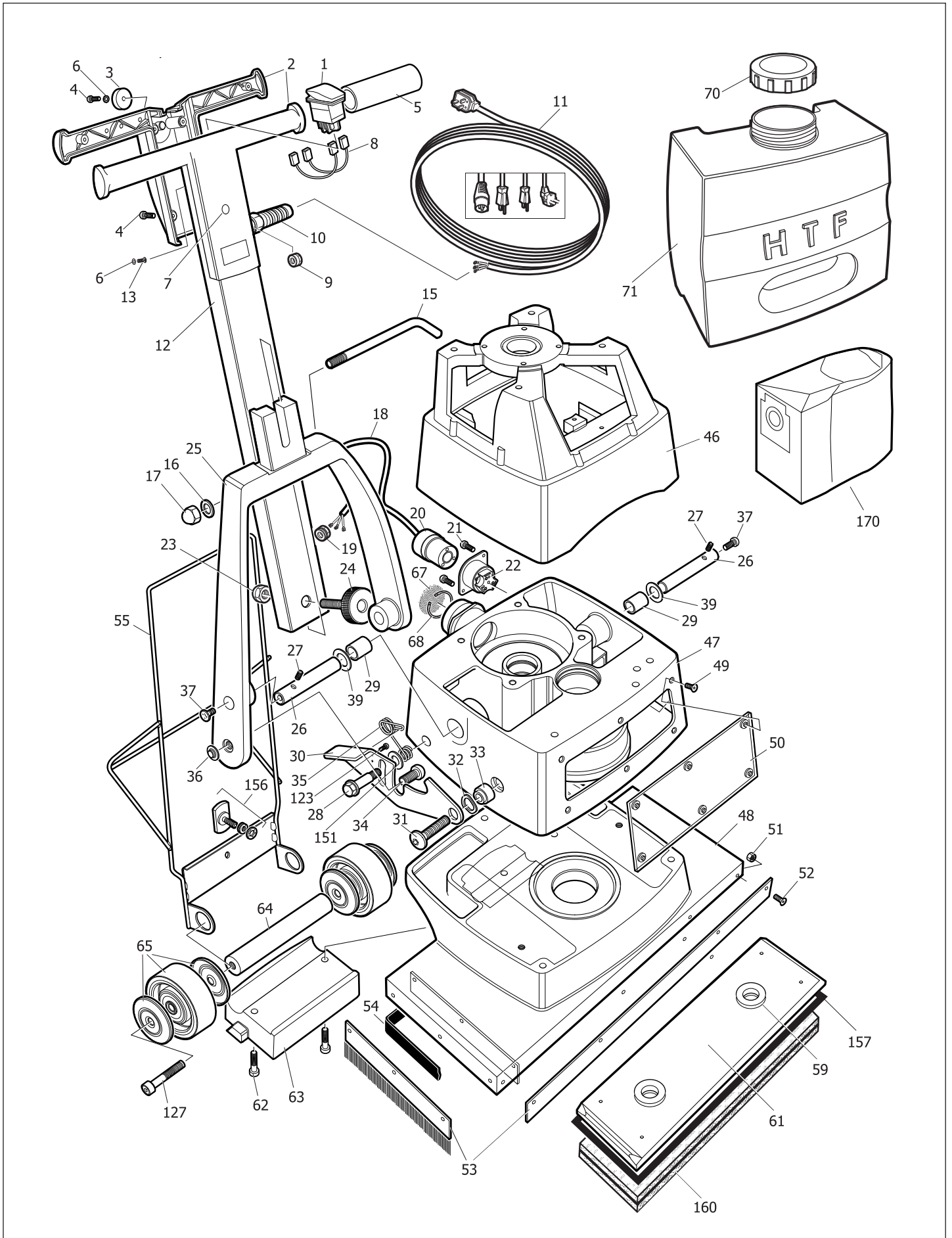

PARTS DIAGRAM

HTF Orbital Floor & Deck Sander

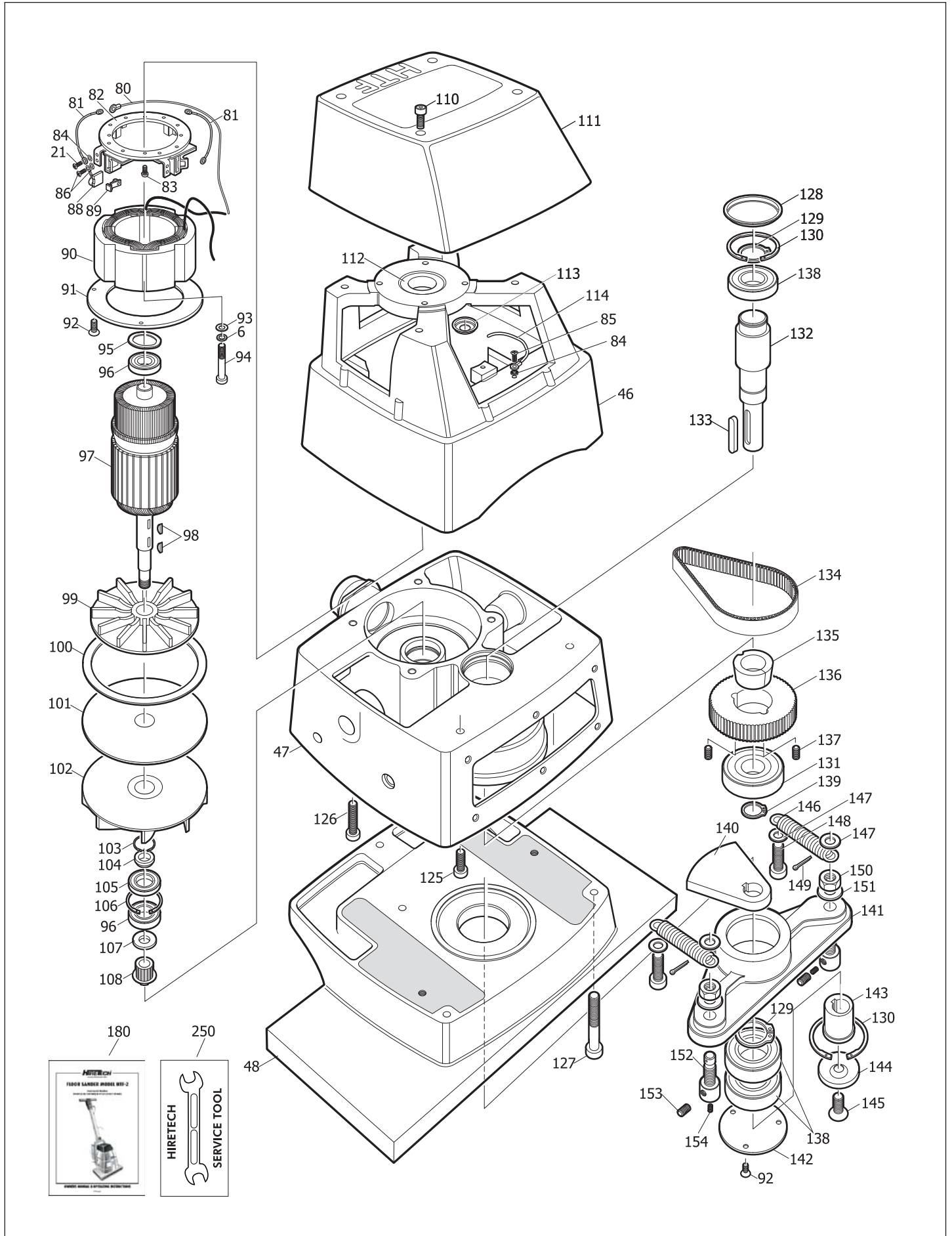

PARTS LIST

Ref	PSTK	Pack Qty	Description
1	011600	1	Switch 220/240 Volt (Bias Off)
1	011610	1	Switch 110/120 Volt (Bias Off)
2	030425	1	Housing Switch Assembly
3	030630	1	Stop Rubber
4	030920	7	Screw
5	031870	2	Grip Hand
6	010270	5	Washer Lock
7	031950	1	Plug Blanking
9	101206	1	Nut Lock
10	101205	1	Strain Relief
11	030660	1	Cable Main Assembly 110Vt (NA)
11	030670	1	Cable Main Assembly 220/240V (UK)
11	030680	1	Cable Main Assembly 110V (UK)
11	030690	1	Cable Main Assembly 220V (EEC)
11	030700	1	Cable Main Assembly 220/240V (AUS)
12	030910	1	Tube Handle Assembly
13	962345	10	Screw
15	164508	1	Hook Cable
16	980197	1	Washer
17	920148	1	Nut
18	030930	1	Handle Cable (NA)
18	030940	1	Handle Cable
18	031000	1	Handle Cable 110 Volt (UK)
19	101220	1	Strain Relief Handle Cable
19	163804	1	Strain Relief Handle Cable (NA)
20	911046	1	Body Twist Lock
21	010210	4	Screw
22	911045	1	Base Twist Lock
23	031910	1	Nut
24	030450	1	Clamp Handle
25	030042	1	Handle Frame
26	031790	2	Pin Pivot
27	031160	2	Screw
28	031900	1	Bolt
29	031800	2	Bush Bearing
30	030222	1	Latch
31	031810	1	Screw
32	031890	1	Washer
33	031880	1	Spacer Latch Pivot
34	031820	1	Screw
35	031840	1	Spring Latch Return
36	031830	1	Cover Screw
37	031850	2	Screw
39	030550	2	Washer
46	030030	1	Housing Motor
47	030022	1	Housing Gear
48	030010	1	Housing Lower
49	031090	6	Screw
50	030270	1	Cover
51	031130	16	Nut
52	031120	16	Screw
53	030360	1	Brush Set
54	030350	1	Bumper
55	030300	1	Support Bag (check Serial No.)
56	031010	4	Bolt
57	031020	4	Wing Nut
58	030390	2	Clamp Abrasive
59	030400	2	Bush
60	030370	1	Sanding Block
61	030380	1	Sanding Block Abrasive Pad
62	030790	4	Screw
63	030060	1	Retainer Wheel
64	030320	1	Housing Eccentric
65	030070	2	Wheel
67	031420	1	Exhaust Guard
68	031430	1	Ring Retainer
70	031310	1	Cap Weight

Ref	PSTK	Pack Qty	Description
71	031320	1	Sanding Weight HTF
80	030990	1	Lead Motor
81	010750	2	Brush Shunt
82	010170	1	Brush Block Assembly
83	010190	4	Screw Pack of 4
84	010200	4	Washer
86	010220	4	Screw and Washer Set
88	010180	4	Brush Motor
89	010230	4	Brush Spring
90	032000	1	Field 110/120 Volt HTF
90	032010	1	Field 220/240 Volt HTF
91	010290	1	Baffle
92	010300	3	Screw
93	010260	2	Washer Clamp
94	010280	2	Screw
95	010600	1	Spring Load
96	010320	2	Bearing
97	010330	1	Armature 110/120 Volt
97	010340	1	Armature 220/240 Volt
98	010350	3	Key
99	010360	1	Fan Motor
100	010370	1	Gasket
101	010380	1	Plate Exhaust
102	010390	1	Fan Intake
103	010400	1	Ring Retainer
104	010410	1	Spacer Bearing
105	010420	1	Seal
106	010430	1	Ring Retainer
107	031520	1	Spacer Pulley
108	030180	1	Pulley Drive
110	010010	4	Screw
111	030090	1	Cover Motor
112	011840	1	Insert Bearing
113	031280	1	Bush Insulator
114	031070	1	Lead Ground (Earth)
123	030760	3	Screw
125	030740	2	Screw
126	031450	4	Screw
127	030820	7	Screw
128	031300	1	Plug Bearing
129	030480	2	Clip
130	030490	2	Clip
131	030470	1	Bearing
132	030130	1	Shaft Drive
133	030510	1	Key
134	030150	1	Belt Drive
135	030170	1	Bush Pulley
136	030190	1	Pulley Driven
137	031170	2	Screw
138	030460	3	Bearing
139	030500	1	Clip
140	030120	1	Balance Weight
141	030080	1	Holder Sanding Pad
142	030410	1	Plate Cover
143	030110	1	Bush Eccentric
144	030440	1	Cap Retaining
145	030780	1	Screw
146	030520	2	Spring Sanding Pad
147	980629	1	Washer
148	030830	2	Screw
149	010680	1	Pin Cotter
150	030850	2	Nut
151	030860	3	Washer
152	030100	2	Pin
153	030600	2	Spring Plunger
154	030840	2	Screw
156	031650	1	Knob Assembly
157	031370	1	Hook and Loop Pad
160	01769	20	Floor Sander Backing/Abrasive Pad HTF

Ref	PSTK	Pack Qty	Description
170	07038	25	Disposable Paper Dust Bag HT7/HTF Pack 2
170	07040	50	Disposable Paper Dust Bag HT7/HTF
180	031390	1	Owners Manual & Operating Instructions

Special Tools (not illustrated)

250	011740	1	Service Tool - Pinion & Pulley Fitting/Removal
250	031490	1	Service Tool - Lever Block Holder HTF
250	031610	1	Service Tool - Jacking Bolts HTF

CIRCUIT DIAGRAM

HTF Orbital Floor & Deck Sander

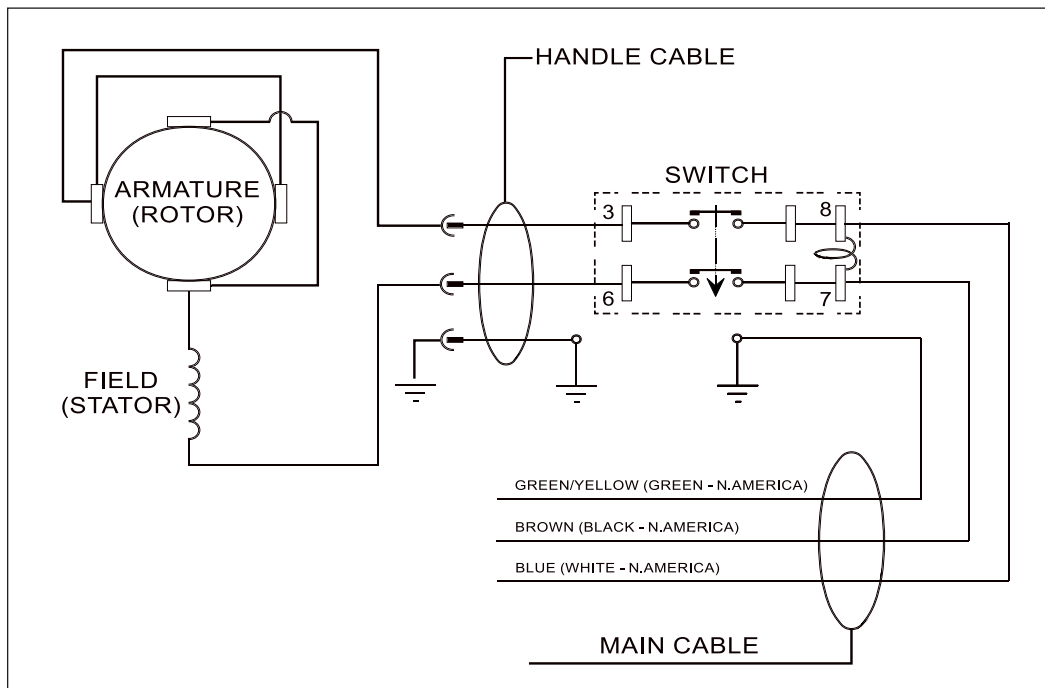

DECLARATION OF CONFORMITY



Manufacturer's Name: Hire Technicians Group Ltd.

Manufacturer's Address:
Chalk Hill House
8 Chalk Hill
Watford
Herts WD1 4BH

declares that the product:

Product Name: Hiretech Floor Sander

Model Name: **HTF-2** 230 Volt 50Hz Insulation Class 1
HTF-2 110 Volt 50Hz Insulation Class 1

conforms to the following:

Machinery Directive (Harmonised) 89/392-EU as amended
Low Voltage Directive (Harmonised) 73/23/EU as amended
Electromagnetic Compatibility Directive 89/336/EU as amended

following the provisions of the directives:

89/392/EU, 93/44EU, 73/23/EU, 93/68/EU, 89/336/EU, 91/368/EU, 92/31/EU
EN60 335-1-88 (HD 251-1-3) BS 3456-201 EN292-1-91
EN292-2-91 EN60204-1-92
EN55014-93 (BS 800) EN 50082-1-92
IEC 745-2-4 (HD 400.2) (BS 2769-2-2.4)

electrical safety test procedures comply with:

IEC 335 pt. 1-2, HD251 1-3 1982, BS 2769 & 3456, CSA C22.2,
KEMA K78A1/W1 & W3, NEMKO 503./89, DIN VDE 0700 1/04.88
HD 264.S2 15/07.86

Where the product is licensed to carry a National Approval Mark it is certified that all such products comply with the terms of that license.

C.J. Hedger, Director of Engineering. 10 March 2014

HIRETECH LIMITED WARRANTY

Hiretech warrants to the original purchaser that the Hiretech machine covered by this warranty is free from defects in workmanship and materials. Should any part fail in the period of two years from the date of the original purchase as a result of a defect, Hiretech will (at its option) either repair or replace the part without charge provided that the machine has been operated in accordance with the Owners Manual and Operating Instructions.

Should any such defect arise, please contact your nearest authorised repair agent. Standard service over land mainland freight costs will be refunded on warranty repairs at the sole discretion of Hiretech or the authorised repair agent. If the repair is non-warranty, the customer will be advised before any work is undertaken.

This warranty is the sole warranty by Hiretech and is in lieu of all other warranties express or implied and releases Hiretech from all other obligations and liabilities.

This warranty does not apply to normal wear and tear to the machine, and in particular does not cover normal wear parts such as mains cable, wheels, switches, relays, brushes, rubber parts, hoses and bearings. This warranty also does not cover, and Hiretech will not be liable for, excessive wear caused by abnormal use.

Hiretech will under no circumstances be liable for alterations to the machine or for damage caused by third persons, or for misuse or abuse of the machine, or damage caused during transportation. Repairs of the machine made or attempted by persons other than those specifically authorised by Hiretech shall render this warranty void and Hiretech will not be liable for such repairs, the cost of such repairs, or the consequences of such repairs. Where spare parts are used on the machine and they do not conform to Hiretech specifications, this warranty will be rendered void and Hiretech will not be liable.

Hiretech will not be liable for any indirect or consequential loss, damage, cost or expense of any kind whatever and however caused whether arising under contract, tort (including negligence) or otherwise including (without limitation) loss of production, loss of profits or contracts or of operating time or goodwill or anticipated savings.

Every effort has been made to present all information in this publication accurately, however no liability is accepted for any inclusions or advice given or for omissions from this publication. Hiretech reserves the right to make changes or improvements to its products without prior notice. Hiretech® is a registered trademark of Hire Technicians Group Ltd., all other trademarks are the property of their respective owners.
© Hire Technicians Group Ltd.

MANUFACTURED BY



HIRE TECHNICIANS GROUP LIMITED
CHALK HILL HOUSE, 8 CHALK HILL, WATFORD,
HERTS, WD19 4BH. UNITED KINGDOM
TEL: +44 (0)1923 332424 FAX: +44 (0)1923 332425
E-mail: sales@hiretech.biz Web: www.hiretech.biz